

# Turn-lock Type All Resin Fitting

New

RoHS

*Prevents leakage due to insufficient tube insertion*

## ■ Ensure secure tube insertion

A mechanism that prevents the tube from being gripped unless it is inserted to the end

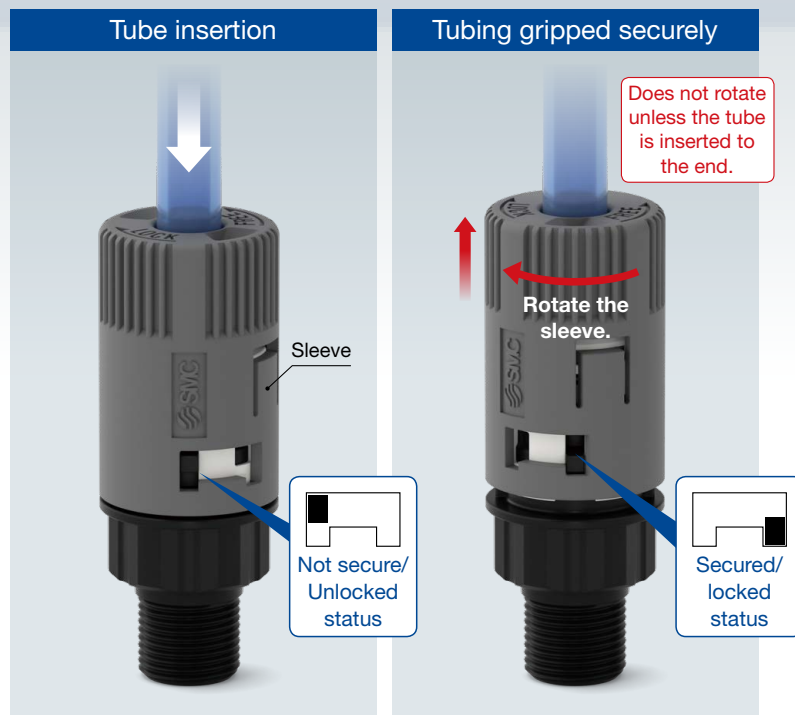

## ■ Visibility of tube grip status is possible.

Equipped with tube grip status indicator

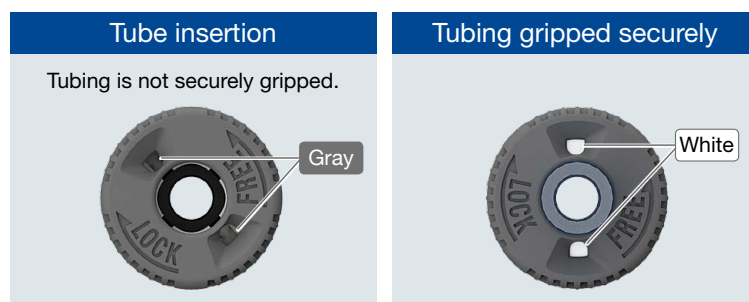

\* For details on how to use this product, please check the operation manual. The tubing will not be twisted even if an external torque is applied after the tubing is secured.



## ■ Grease-free

## ■ Fluid: Air, Nitrogen, Water, Pure water, Some chemicals\*<sup>1</sup>

\*<sup>1</sup> Refer to page 4 for details on the applicable fluids.

## ■ Operating temperature range: 0 to 80°C

## ■ All resin (Non-Metal) (except rubber)

No metal parts used. No metallic pollution  
Made of PPS-GF30 with excellent chemical resistance

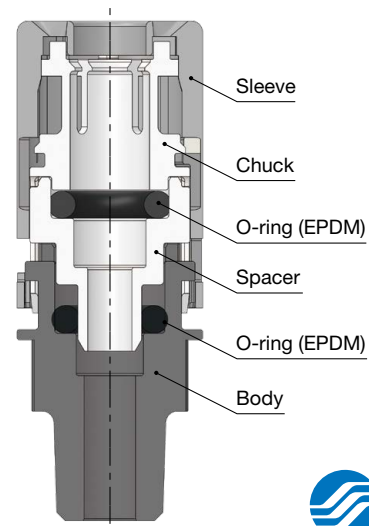

**KY Series**

**SMC**

CAT.ES20-322A

## ■ Reduced risk of leakage

Eliminates the risk of leakage caused by chuck biting along surface, as the tube is not damaged when inserted.

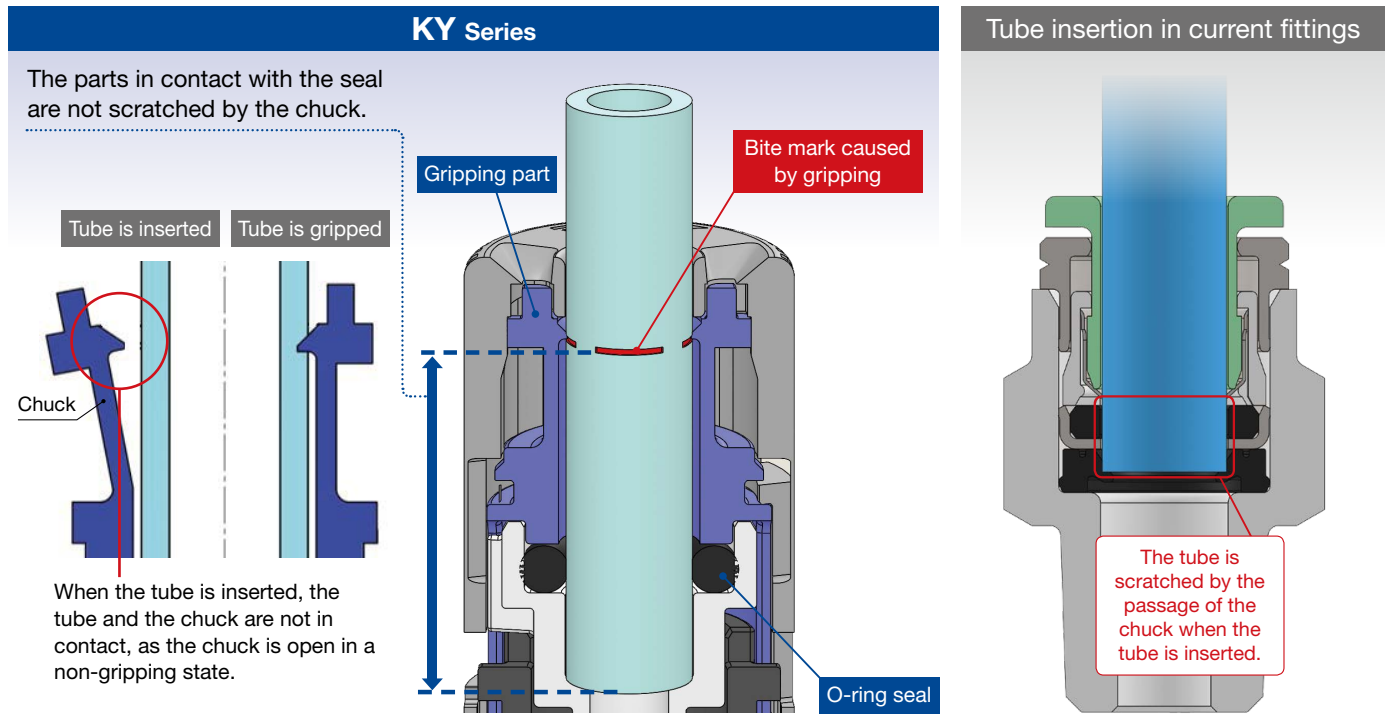

## ■ Product Map

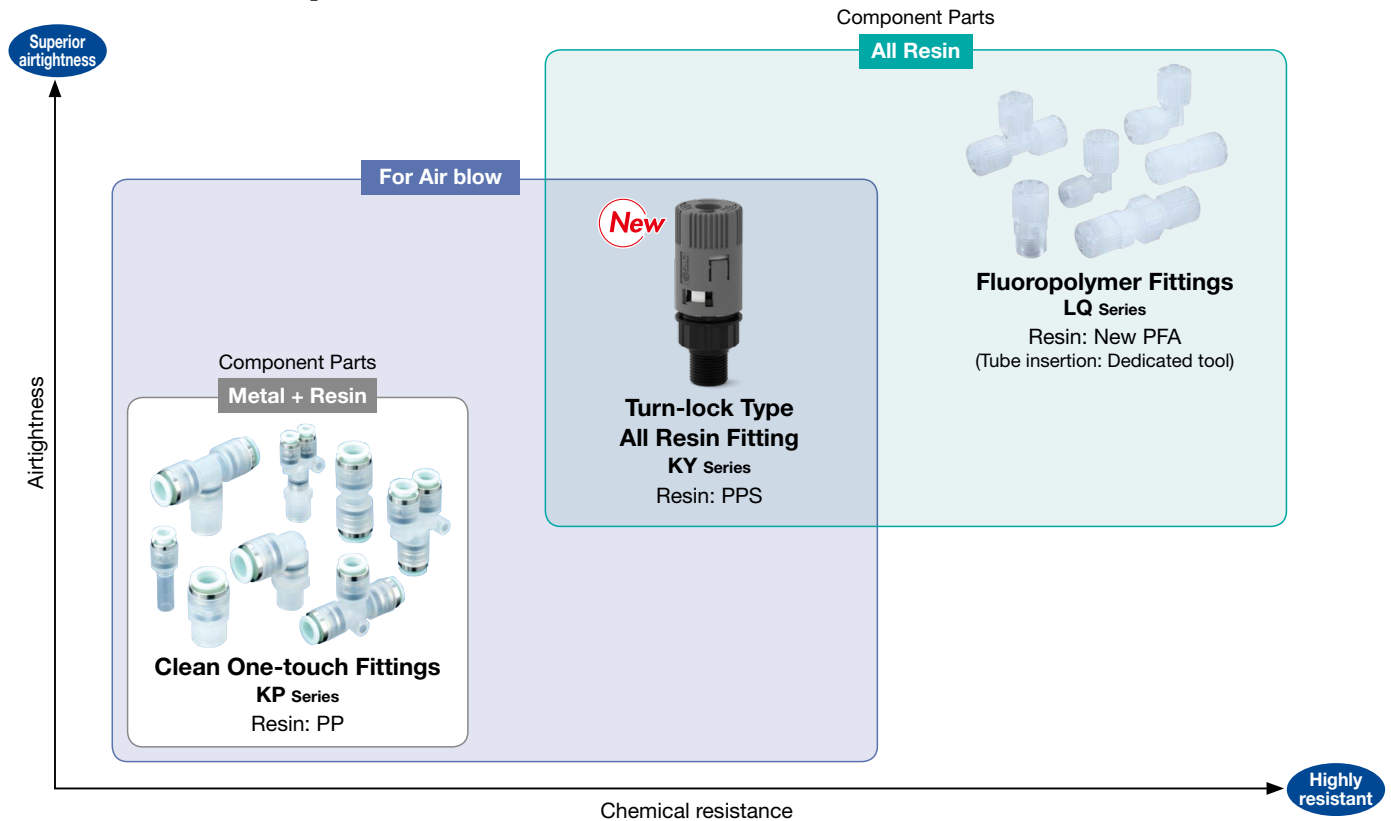

## Application Examples

N<sub>2</sub> purge to silicon wafer, etc.

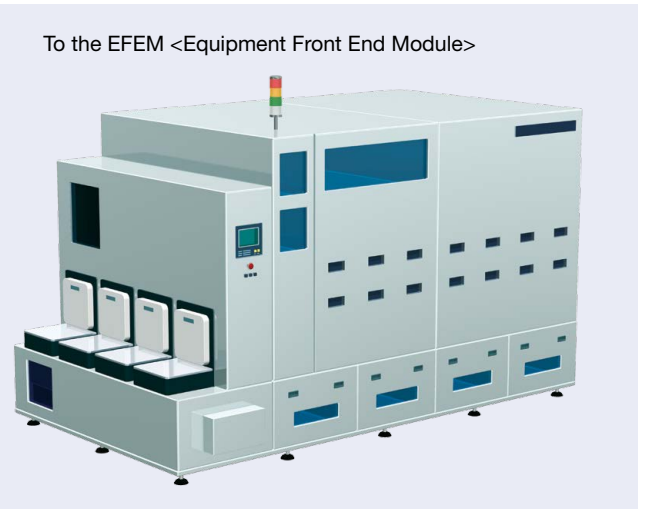
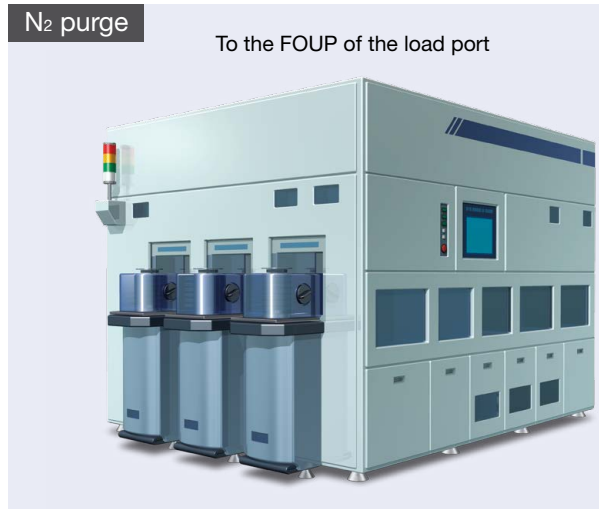
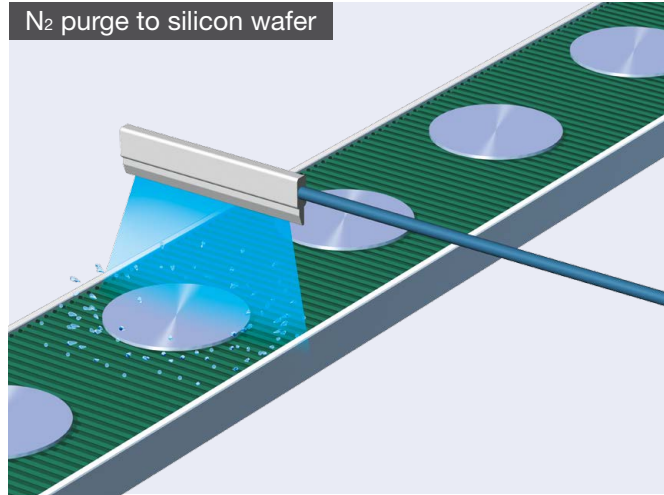

# Turn-lock Type All Resin Fitting *KY Series*



## Applicable Tubing

|                 |                 |
|-----------------|-----------------|
| Tubing material | PFA, Polyolefin |
| Tubing O.D.     | ø1/4"           |

## Specifications

|                                |   |
|--------------------------------|---|
| Cleanliness class (ISO class)  | Class 3*1   |
| Fluid                          | Air, N <sub>2</sub> , Water, Pure water, Some chemicals*2 |
| Components                     | PPS, EPDM   |
| Lubricant                      | Grease-free specification                                 |
| Operating pressure range       | 0 to 1.0 MPa  |
| Max. operating pressure        | 1.0 MPa*3   |
| Proof pressure                 | 1.5 MPa   |
| Ambient and fluid temperatures | 0 to 80°C   |
| Threads                        | JIS B0203 (Taper thread for piping)                       |

\*1 Refer to particle generation classifications.

\*2 Refer to page 4 for details of Chemical liquids.

\*3 The surge pressure must be under the maximum operating pressure.

### ⚠ Caution

**Not suitable for driving system air piping**

Seal material: the durability of EPDM with respect to mineral oils is inferior.  
Use the KPQ and KPG series for driving system air piping.

## Made to Order

Made to Order

With pipe tape

**X53**

## How to Order

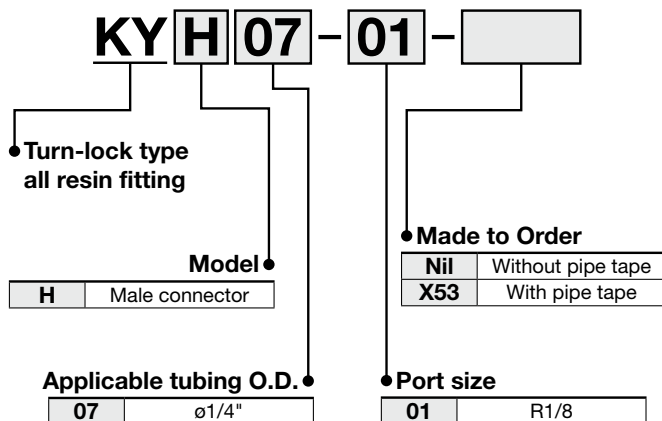

## Particulate Generation Classifications

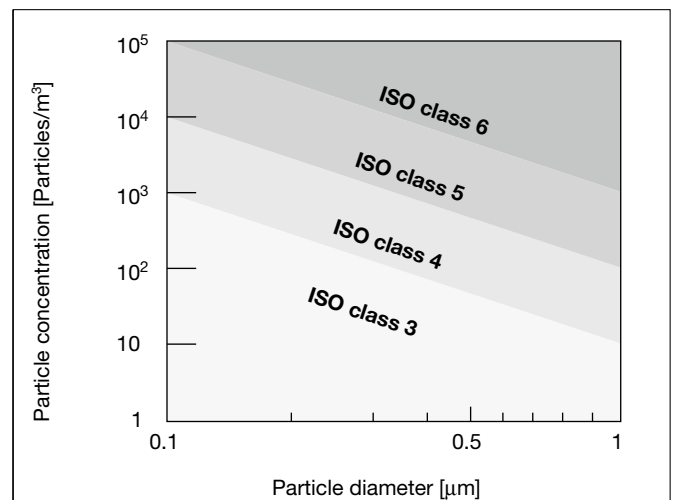

\* Refer to the **Web Catalog** for details.

## Dimensions

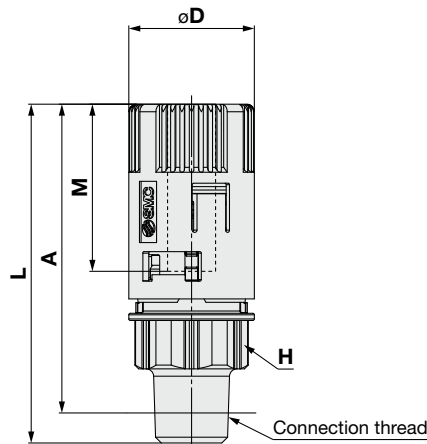

| Applicable tubing O.D. | Connection thread R | Model           | H<br>(Width across flat) | øD    | L<br>(Max.) | A*1<br>(Max.) | M    | Effective area [mm <sup>2</sup> ] | Weight [g] |
|------------------------|---------------------|-----------------|--------------------------|-------|-------------|---------------|------|-----------------------------------|------------|
| 1/4"                   | 1/8                 | <b>KYH07-01</b> | 14                       | ø16.6 | 44.8        | 40.9          | 22.1 | 12.3                              | 8.3        |

[mm]

\*1 Reference dimension for R threads after installation

## ⚠ Applicable Fluids

### Material and Fluid Compatibility Check List

| Chemical   | Body                               | Seal                              |
|--|------------------------------------|-----------------------------------|
|  | Polyphenylene sulfide resin<br>PPS | Ethylene propylene rubber<br>EPDM |
| Acetone  | ○                                  | ○                                 |
| Ammonium hydroxide   | ○                                  | ○                                 |
| Isobutyl alcohol   | ○                                  | —                                 |
| Isopropyl alcohol  | ○                                  | —                                 |
| Hydrochloric acid  | ○                                  | ○                                 |
| Ozone (dry)  | ○                                  | ○                                 |
| Hydrogen peroxide<br>Concentration 5% or less, 50°C or less          | ○                                  | ○                                 |
| Ethyl acetate  | ○                                  | ○                                 |
| Butyl acetate  | ○                                  | ○                                 |
| Nitric acid (except fuming nitric acid)<br>Concentration 10% or less | ○                                  | ○                                 |
| DI water (deionized water)   | ○                                  | ○                                 |
| Sodium hydroxide (caustic soda)<br>Concentration 50% or less         | ○                                  | ○                                 |
| Nitrogen gas   | ○                                  | ○                                 |
| Ultrapure water  | ○*1                                | ○                                 |
| Toluene  | ○                                  | ×                                 |

○: Can be used or can be used under certain conditions.  
 ×: Cannot be used.  
 —: No data

\*1 This product has corrosion resistance. However, due to the elution of components, the preservation of the purity level of ultrapure water cannot be guaranteed.

\* The above data shows compatibility guidelines based upon component parts. Therefore, it is no guarantee of product performance. In addition, using fluids other than those specified in the catalog are not covered by the product's warranty.



## KY Series

# Specific Product Precautions

Be sure to read this before handling the products. Refer to the back cover for safety instructions. For fittings and tubing precautions, refer to the “Handling Precautions for SMC Products” and the “Operation Manual” on the SMC website: <https://www.smcworld.com>

### Connection Thread Tightening Method

#### Caution

Be sure to wrap sealing tape around the taper threads for resin threads. If used without sealing tape leakage can occur.

1. Winding of sealant tape  
Wrap the pipe tape 2 to 3 times around the threads, leaving 1 to 1.5 thread ridges exposed at the end of the threads.
2. Tightening
  - 1) Tighten approx. 5.5 revolutions after the screw begins to engage. Tightening torque is 4 to 6 N as a guide.  
Note that the guideline may vary depending on the condition of the sealing tape and female threads.  
When tightening, apply a wrench of the correct size.
  - 2) Insufficient tightening may cause seal failure or loosen the threads.

### Installation and Removal of Tubing

#### Caution

##### 1. Installation of tubing

Grease is not used due to the KY series oil-free specifications. For this reason, greater insertion force is required when tubing is installed. The tubing may kink when inserted. Hold the end of the tubing, and insert it all the way in slowly and securely. Refer to dimension “M” in the dimension drawings for guidance on the insertion depth of tubing.

##### 2. Removal of tubing

The outside diameter of tubing used at high temperatures or for long periods of time will expand, and in some cases pipe fittings cannot be reattached. Tubing that cannot be attached should be replaced with new one.

##### 3. Operating tubing

Do not use any other tubing besides ones listed in specification. Tubing may be ejected if non applicable tubing is used.

##### 4. Fitting connects the piping

When installing, leave at least 15 mm between joints. If the distance is too small, it may not be possible to install the tubing.

##### 5. Number of times tubing can be connected and disconnected

It is recommended to connect and disconnect up to 5 times as a guideline.

### Operating Environment

#### Warning

1. Do not use in environments or locations where there is a danger of damage to fittings and tubing.

For fitting and tubing materials, refer to specifications and construction drawings, etc.

2. Do not expose the product to direct sunlight for an extended period of time.

#### Caution

1. Store away from direct sunlight at 40°C or less.
2. The PPS resin may change color when exposed to sunlight, fluorescent light, mercury lamps, high temperature and etc. for long periods. The color change does not affect the product performance.
3. Not suitable for driving system air piping

Seal material: the durability of EPDM with respect to mineral oils is inferior.

Use the KPQ and KPG series for driving system air piping.

### Maintenance

#### Caution

##### 1. Tightening of resin taper threads for piping

Since the KY series taper threads are made of resin, minute leakage may gradually occur due to stress relaxation. Perform periodic inspections, and if leakage is detected correct the problem by further tightening. If additional tightening becomes ineffective, replace the fitting with a new product.

##### 2. Check for the following during regular maintenance, and replace components as necessary.

- a) Scratches, gouges, abrasion, corrosion
- b) Leakage, refer to item 3 regarding taper thread leakage.
- c) Twisting, flattening or distortion of tubing
- d) Hardening, deterioration or softness of tubing

##### 3. Do not repair or patch the replaced tubing or fittings for reuse.

## Safety Instructions

These safety instructions are intended to prevent hazardous situations and/or equipment damage. These instructions indicate the level of potential hazard with the labels of “**Caution**,” “**Warning**” or “**Danger**.” They are all important notes for safety and must be followed in addition to International Standards (ISO/IEC)\*1), and other safety regulations.

 **Danger :** **Danger** indicates a hazard with a high level of risk which, if not avoided, will result in death or serious injury.

 **Warning:** **Warning** indicates a hazard with a medium level of risk which, if not avoided, could result in death or serious injury.

 **Caution:** **Caution** indicates a hazard with a low level of risk which, if not avoided, could result in minor or moderate injury.

\*1) ISO 4414: Pneumatic fluid power - General rules and safety requirements for systems and their components  
ISO 4413: Hydraulic fluid power - General rules and safety requirements for systems and their components  
IEC 60204-1: Safety of machinery - Electrical equipment of machines - Part 1: General requirements  
ISO 10218-1: Robots and robotic devices - Safety requirements for industrial robots - Part 1: Robots etc.

### Warning

#### 1. The compatibility of the product is the responsibility of the person who designs the equipment or decides its specifications.

Since the product specified here is used under various operating conditions, its compatibility with specific equipment must be decided by the person who designs the equipment or decides its specifications based on necessary analysis and test results. The expected performance and safety assurance of the equipment will be the responsibility of the person who has determined its compatibility with the product. This person should also continuously review all specifications of the product referring to its latest catalog information, with a view to giving due consideration to any possibility of equipment failure when configuring the equipment.

#### 2. Only personnel with appropriate training should operate machinery and equipment.

The product specified here may become unsafe if handled incorrectly. The assembly, operation and maintenance of machines or equipment including our products must be performed by an operator who is appropriately trained and experienced.

#### 3. Do not service or attempt to remove product and machinery/equipment until safety is confirmed.

1. The inspection and maintenance of machinery/equipment should only be performed after measures to prevent falling or runaway of the driven objects have been confirmed.
2. When the product is to be removed, confirm that the safety measures as mentioned above are implemented and the power from any appropriate source is cut, and read and understand the specific product precautions of all relevant products carefully.
3. Before machinery/equipment is restarted, take measures to prevent unexpected operation and malfunction.

#### 4. SMC products cannot be used beyond their specifications. They are not developed, designed, and manufactured to be used under the following conditions or environments. Use under such conditions or environments is not allowed.

1. Conditions and environments outside of the given specifications, or use outdoors or in a place exposed to direct sunlight.
2. Use for nuclear power, railways, aviation, space equipment, ships, vehicles, military application, equipment affecting human life, body, and property, combustion equipment, entertainment equipment, emergency shut-off circuits, press clutches, brake circuits, safety equipment, etc., and use for applications that do not conform to standard specifications such as catalogs and operation manuals.
3. Use for interlock circuits, except for use with double interlock such as installing a mechanical protection function in case of failure. Please periodically inspect the product to confirm that the product is operating properly.

### Caution

**SMC develops, designs, and manufactures products to be used for automatic control equipment, and provides them for peaceful use in manufacturing industries.**

**Use in non-manufacturing industries is not allowed.**

Products SMC manufactures and sells cannot be used for the purpose of transactions or certification specified in the Measurement Act of each country. The new Measurement Act prohibits use of any unit other than SI units in Japan.

### Limited warranty and Disclaimer/ Compliance Requirements

The product used is subject to the following “Limited warranty and Disclaimer” and “Compliance Requirements”.

Read and accept them before using the product.

#### Limited warranty and Disclaimer

1. The warranty period of the product is 1 year in service or 1.5 years after the product is delivered, whichever is first.\*2)  
Also, the product may have specified durability, running distance or replacement parts. Please consult your nearest sales branch.
2. For any failure or damage reported within the warranty period which is clearly our responsibility, a replacement product or necessary parts will be provided.  
This limited warranty applies only to our product independently, and not to any other damage incurred due to the failure of the product.
3. Prior to using SMC products, please read and understand the warranty terms and disclaimers noted in the specified catalog for the particular products.

\*2) **Suction cups (Vacuum pads) are excluded from this 1 year warranty.**

A suction cup (vacuum pad) is a consumable part, so it is warranted for a year after it is delivered.

Also, even within the warranty period, the wear of a product due to the use of the suction cup (vacuum pad) or failure due to the deterioration of rubber material are not allowed by the limited warranty.

#### Compliance Requirements

1. The use of SMC products with production equipment for the manufacture of weapons of mass destruction (WMD) or any other weapon is strictly prohibited.
2. The exports of SMC products or technology from one country to another are governed by the relevant security laws and regulations of the countries involved in the transaction. Prior to the shipment of a SMC product to another country, assure that all local rules governing that export are known and followed.

## Safety Instructions

Be sure to read the “Handling Precautions for SMC Products” (M-E03-3) and “Operation Manual” before use.